

# Los Angeles Fire Department

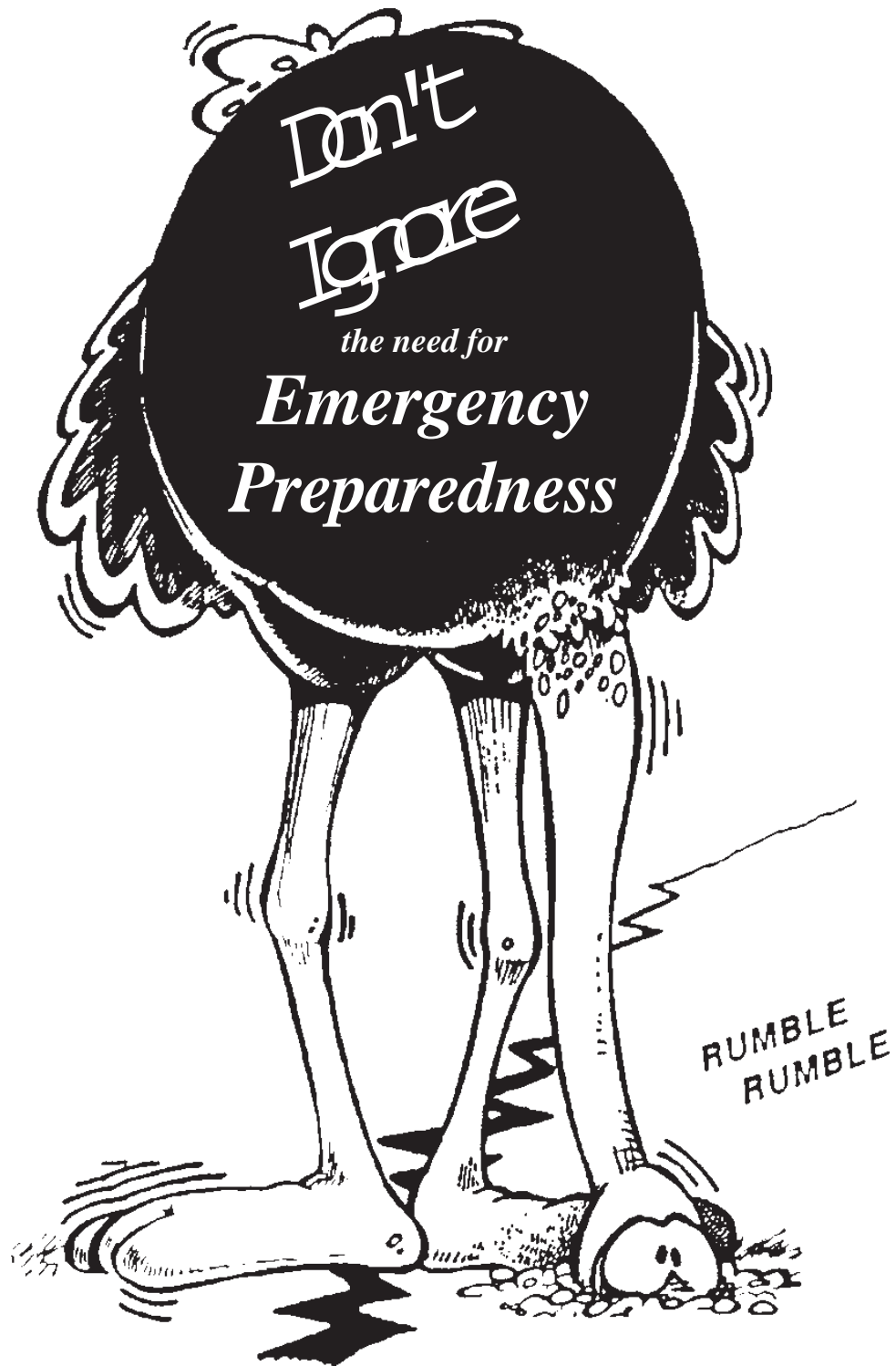

This book is available on the web at:

<http://www.cert-la.com/Ostrich.pdf>

**WWW.LAFD.ORG**

Prepared as a public service by the  
Disaster Preparedness Unit  
Fire & Safety Education Unit

**2001 Edition**

# *EMERGENCY PREPAREDNESS*

To those of us who live and work in the Greater Los Angeles area, earthquakes and other natural emergencies are a reality. In order to deal with this situation, emergency preparedness must become a way of life. In the event of a major earthquake or disaster, freeways and surface streets may be impassable and public services could be interrupted or taxed beyond their limits. Therefore, everyone must know how to provide for their own needs for an extended period of time, whether at work, home, or on the road.



Our goal in distributing this booklet is to encourage you to prepare for a major disaster and to maintain that readiness. Part of becoming ready is having the necessary supplies. Earthquakes and major disasters, in our area, can happen at any time. They are not totally predictable. There may be long periods between disasters. This is why it is important to maintain fresh emergency supplies through rotation of older stock into daily use. The quality of life and the potential for survival are greatly increased by being prepared.

*William R. Bamattre*  
Chief Engineer and General Manager  
Los Angeles Fire Department

As a covered entity under Title II of the Americans with Disabilities Act, the City of Los Angeles does not discriminate on the basis of disability and, upon request, will provide reasonable accommodation to ensure equal access to its programs, services, and activities. For additional information, please contact the Los Angeles City Fire Department, Fire & Safety Education Unit at (818) 756-9671.

Copyright © 2001 by the City of Los Angeles Fire Department, All rights reserved.  
LAFD - Disaster Preparedness Unit and Fire & Safety Education Unit

The Los Angeles City Fire Department encourages the reproduction and distribution of this book. There is no charge for permission to reproduce this book. No approval is necessary to reproduce this book in its entirety (without additions or deletions). The book may not be sold or used for commercial purposes. There can be no conditions, provisos, nor quid pro quos associated with its free distribution.

Contact LAFD, Disaster Preparedness (818) 756-9674, for additional uses, conditions & approvals.



# ***TABLE OF CONTENTS***

TABLE OF CONTENTS .....	3
EARTHQUAKE TIPS: .....	4
FAMILY & HOME PLANNING .....	5
HOME & OFFICE FIRST AID KIT .....	6
USEFUL SUPPLIES AND EQUIPMENT .....	7
FAMILY EARTHQUAKE PLAN .....	8
SAFE DRINKING WATER .....	10
PURIFYING YOUR TAP WATER .....	11
STRAPPING REQUIREMENTS FOR WATER HEATERS .....	12
PORTABLE/AUTO SURVIVAL KIT .....	14
EMERGENCY LIGHTING: .....	15
COOKING AFTER THE EARTHQUAKE: .....	15
EMERGENCY FOOD SUPPLY .....	16
SAMPLE FOOD STORAGE ITEMS .....	17
HOW TO SHUT OFF UTILITIES .....	18
SECURING HEAVY FURNISHINGS .....	21
HELPING CHILDREN COPE .....	24
ADULT COPING WITH DISASTERS .....	25
EMERGENCY COMMUNICATIONS .....	26
EMERGENCY CONTACT CARDS .....	27
EMERGENCY OUT-OF-STATE CONTACT .....	27
SEISMIC GAS SHUT-OFF VALVES .....	30
TYPES OF FIRE EXTINGUISHERS .....	32
FIRE SAFETY .....	33
UPON DISCOVERY OF A FIRE .....	33
REPORT ALL FIRES AND SMOKE .....	33
FAMILY FIRE SAFETY PLAN .....	34
ADDRESSES .....	35
SECURITY BARS .....	35
APARTMENTS .....	35
FIRE SAFETY EQUIPMENT .....	36
SMOKE DETECTORS .....	36
IF YOU ARE TRAPPED IN A ROOM OR APARTMENT .....	36
FIRE - SPECIFIC HAZARDS .....	37
SPRINKLERS .....	37
FLAMMABLE OR COMBUSTIBLE LIQUIDS .....	37
SPONTANEOUS HEATING .....	37
CLOTHING FIRES .....	38
UPHOLSTERY FIRES .....	38

# EARTHQUAKE TIPS:

## DURING AN EARTHQUAKE

When you feel an earthquake, duck under a desk or sturdy table. Stay away from windows, bookcases, file cabinets, heavy mirrors, hanging plants, and other heavy objects that could fall. Watch out for falling plaster and ceiling tiles. Stay under cover until the shaking stops. Hold onto your cover. If it moves, move with it. Here are some additional tips for specific locations.

- ☞ If you're in a **HIGH-RISE BUILDING**, and you are not near a desk or table, move against an interior wall, and protect your head with your arms. Do not use the elevators. Do not be surprised if the alarm or sprinkler systems come on. Stay indoors, glass windows can dislodge during the quake and sail for hundreds of feet.
- ☞ If you're **OUTDOORS**, move to a clear area, away from trees, signs, buildings, or electrical wires and poles.
- ☞ If you're on a **SIDEWALK NEAR BUILDINGS**, duck into a doorway to protect yourself from falling bricks, glass, plaster, and other debris.
- ☞ If you're **DRIVING**, pull over to the side of the road and stop. Avoid overpasses, power lines, and other hazards. Stay inside the vehicle until the shaking is over.
- ☞ If you're in a **CROWDED STORE OR OTHER PUBLIC PLACE**, do not rush for exits. Move away from display shelves containing objects that could fall.
- ☞ If you're in a **WHEELCHAIR**, stay in it. Move to cover, if possible, lock your wheels, and protect your head with your arms.
- ☞ If you're in the **KITCHEN**, move away from the refrigerator, stove, and overhead cupboards. (Take time **NOW** to anchor appliances and install security latches on cupboard doors to reduce hazards.)
- ☞ If you're in a **STADIUM OR THEATER**, stay in your seat and protect your head with your arms. Do not try to leave until the shaking is over. Then leave in a calm, orderly manner. Avoid rushing toward exits.

## AFTER THE EARTHQUAKE

### QUICK-CHECKLIST

Be prepared for aftershocks, and plan where you will take cover when they occur.

- Check for injuries. Give first aid as necessary.
- Remain calm and reassure others.
- Avoid broken glass.
- Check for fire. Take appropriate actions and precautions.
- Check gas, water and electric lines. If damaged, shut off service. If gas is leaking, don't use matches, flashlights, appliances or electric switches. Open windows, leave building and report to gas company.
- Replace all telephone receivers and use for emergency calls only.
- Tune to the emergency broadcast station on radio or television. Listen for emergency bulletins.
- Stay out of damaged buildings.

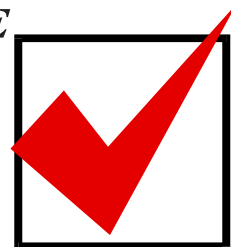

# FAMILY & HOME PLANNING

## INDIVIDUAL & FAMILY READINESS

- Create a Family Earthquake Plan.
- Know the safe spot in each room. Under sturdy tables, desks, or against inside walls.
- Know the danger spots. Windows, mirrors, hanging objects, fireplaces, and tall furniture.
- Conduct practice drills. Physically place yourself and your children in safe locations.
- Learn first aid and CPR (cardiopulmonary resuscitation) from your local Red Cross or other community organization.
- Decide where your family will reunite if separated.
- Keep a list of emergency phone numbers.
- Choose an out-of-state friend or relative whom family members can call after the quake to report your condition. (See Pg. 27)



## HOME PREPAREDNESS

- Learn how to shut off gas, water, and electricity in case the lines are damaged.
- Check chimneys, roofs and wall foundations for stability.  
*Note: If your home was built before 1935, make sure your house is bolted to its foundation. If your home is on a raised foundation make sure the cripple walls have been made into shear walls. Call a licensed contractor if you have any questions.*
- Secure water heater and appliances that could move enough to rupture utility lines.
- Keep breakable and heavy objects on lower shelves.
- Put latches on cabinet doors to keep them closed during shaking.
- Keep flammable or hazardous liquids such as paints, pest sprays or cleaning products in cabinets or secured on lower shelves.
- Maintain emergency food, water, medicine, first aid kit, tools and clothing.

## COMMUNITY PREPAREDNESS

- Suggest that local organizations of which you are a member undertake a specific preparedness program or acquire special training to be of assistance in the event of a damaging earthquake.
- Participate in neighborhood earthquake preparedness programs.
- Attend training for neighborhood residents in preparedness, first aid, fire suppression, damage assessment and search & rescue.
- Develop self-help networks between families and your neighborhood through a skills and resources bank which includes a listing of tools, equipment, materials and neighborhood members who have special skills and resources to share.
- Identify neighbors who have special needs or will require special assistance.
- Have your neighborhood develop a secret signal to notify friends if everyone and everything is OK. Don't use obvious signals. This could identify vacant houses to criminals.

The Los Angeles Fire Department offers many FREE programs for training and preparing the public.

- CERT - Community Emergency Response Team Training
- Fire Extinguisher Training
- Fire Safety Training
- Earthquake Training
- Disaster Preparedness

# HOME & OFFICE FIRST AID KIT

## MEDICATIONS:

(Buy only currently dated stock, and rotate your supply. We recommend rotating stock at the same time you change your clocks for Daylight Savings Time)

- Antibiotic ointment
- Necessary medications (prescriptions, etc.) Don't forget pediatric medications for the children.
- Aspirin and/or pain relief medication
- Diarrhea medication
- Eye drops
- Cold/cough medicine
- Antihistamines (Benadryl)
- Insect spray
- Ear and nose drops
- Hydrogen peroxide
- Skin disinfectant spray
- NOTE: Prescription medications are expensive and you don't want them to go bad in storage. Simply acquire one additional bottle of medication and store it in a cool dark place. Then use this bottle next when you run out. A newly purchased bottle will then go back into your emergency storage location.

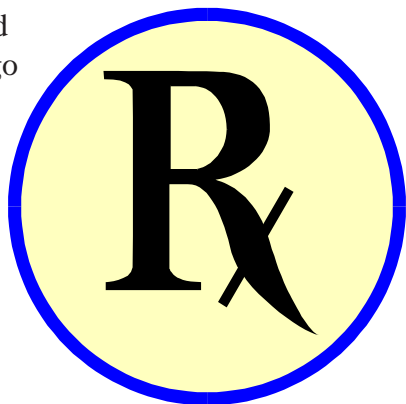

## MEDICAL MATERIALS:

- Band-Aids, large and small
- Medical latex gloves
- Surgical mask
- Instant cold and heat packs
- Ace bandages
- Butterfly bandages
- Gauze pads, 4" x 4"
- Cotton swabs
- Adhesive tape 2"
- 2" & 4" wide sterile bandage roll
- Triangular bandage for sling, etc. Use 48" unbleached muslin. Cut a 48" square then cut it diagonally to make two triangular bandages.
- Tongue depressors (popsicle sticks)
- Splint material
- Spray bottle with 10% bleach solution for disinfecting objects.

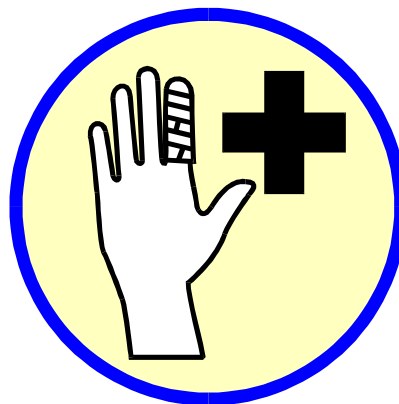

**DON'T FORGET! YOU SHOULD KEEP A COPY OF THE RED CROSS BASIC AND ADVANCED FIRST AID MANUALS WITH YOUR EARTHQUAKE SUPPLIES**



# USEFUL SUPPLIES AND EQUIPMENT

- Work gloves
- Ax/maul (min. 6lb.)
- Shovel (flathead and pointed)
- Broom
- Hammer and nails
- Screwdrivers
- Crowbar or claw tool (36" or longer)
- Plastic sheeting rolls (4 mil. 10' x 25')
- Plastic garbage bags (heavy-duty, 30-gal. or larger)
- Small and large plastic bags
- Coils of rope 1/4", 1/2", 3/4" x 25' or 50'
- Coil of wire
- Tent (family or tube-type)
- Tarp (P.V.C. or canvas, min. 2 ea., 8' x 10')
- Sleeping bags, blanket, or space blanket
- Cheesecloth (to strain particles from water before you treat it)

- CASH MONEY** (small denominations & coins)
- Dry food
- Water
- Clothing
- Walking shoes and socks
- Local road map
- Fire extinguisher (We recommend a dry chemical type with a minimum size rating of **2A-10BC**, with an earthquake restraining strap, a hose-type nozzle, and a metal head.)
- Compass
- Flashlight w/extra batteries, or chemical lightsticks
- Matches, in waterproof container
- Small radio w/extra batteries (battery-powered portable)
- Entertainment Pack - Family photos, notebooks, literature, and games



---

## DON'T FORGET SANITATION SUPPLIES



- Plastic Bags -zip lock type & heavy-duty garbage can size
- Powdered Chlorine Lime - (proper storage is required- it is an oxidizer and it is corrosive)
- Portable camp toilet
- Chemicals for portable toilets
- Toilet paper
- Handi-wipes, Wet-N-Drys, etc. for water-free cleanup
- Toilet Supplies -towelettes, shampoo, toothpaste, deodorant, sanitary napkins, etc.
- Insect/fly/mosquito & ant sprays

# FAMILY EARTHQUAKE PLAN

## KNOW YOUR ENVIRONMENT

### ***SAFEST PLACE IN THE HOME:***

During an earthquake, stay away from heavy furniture, appliances. Large panes of glass, shelves holding heavy objects, and masonry veneer (such as the fireplace). These items tend to fall or break and can injure you. Usually, a hallway is one of the safest places if it is not crowded with objects. Kitchens and garages tend to be the most dangerous. Also know the safest place in each room. It will be difficult to move from one place to another during a severe earthquake.



### ***EXITS AND ALTERNATIVE EXITS:***

Always know **all** the possible ways to exit your house and work place in emergency situations. Try to discover exits that would only be available to you in an emergency (windows).

### ***LOCATION OF SHUT-OFF VALVES:***

Know the location of the shut-off valves for water, gas, and electricity, and how to operate the valves. If you are not sure, contact your utility company.

## MAKE SPECIAL PROVISIONS



### ***ELDERLY, DISABLED, OR PERSONS UNDER MEDICATION:***

These people may have difficulty moving around after an earthquake. Plan to have someone help them to evacuate if necessary. Also, they may need special foods or medication. Be sure to store several days' supply of these special provisions.

### ***PERSONS WHO DON'T SPEAK ENGLISH:***

People who cannot speak English often rely on their family or friends for information. If they are separated during an earthquake, they may need help. Prepare emergency information cards, written in English, indicating identification, address, and special needs.

### ***PETS:***

After an earthquake, you should be concerned with your own safety before taking care of your pets. Storing extra food and water for pets is always a good idea. Keep pets in a secure place at home after an earthquake.

**IMPORTANT NOTE: If you are evacuated, PETS will not be allowed at the emergency shelter.**



# ***FAMILY EARTHQUAKE PLAN*** CON'T

## ***KNOW YOUR COMMUNITY***

### ***POLICE AND FIRE:***

Know the location of the nearest Police Station. Be aware that local Fire Stations will most probably be empty and locked up for days after an earthquake.

### ***SHELTER AND MEDICAL CARE:***

After a damaging earthquake, emergency shelters and temporary medical centers will be set up in your community. Contact your local and state Office of Emergency Services to find out the plans for your area.



## ***COMMUNITY PLANS:***

Know your neighbors and their skills: you may be able to help each other after an earthquake. Also know where to go to help your community after a disaster. It may be days before outside emergency assistance arrives. It is important to help each other.

### ***PLAN TO MEET***

### ***PLAN TO REUNITE:***

Make a plan on where and how to unite family members. Choose a person outside the immediate area to contact if family members are separated. Long distance phone service will probably be restored sooner than local service. Remember, don't use the phone immediately after an earthquake, and make local calls only for emergencies.

### ***PLAN RESPONSIBILITIES***

There will be many things to take care of after an earthquake. Make a plan with your family, friends, and neighbors assigning specific responsibilities to each person. Remember that it may be difficult to get around after an earthquake, so each person's tasks should be related to where they may be.

### ***DEVELOP A MESSAGE DROP***

You need to identify a secure location outside your home where family members can leave messages for each other. This way if you're separated, and unable to remain in your home, your family will know where to go to find you.

You don't want to publicize that you are not at home. That is why this location should be secure and discreet, i.e., under a paving stone, inside a tin can, in the back yard, etc.

# SAFE DRINKING WATER

## WATER IS THE MOST IMPORTANT ITEM TO STORE

Loss of safe drinking water can be deadly. Most people, with few exceptions, will be feeling the effects if they do without water for more than 36 hours. Dehydration occurs much quicker than starvation. Our bodies can tolerate the loss of food much better. With an ample water supply, starvation is delayed many days, even weeks.



The City water supply is vulnerable to the effects of a large earthquake. Contaminants can get into the drinking water supply through ruptures in the pipes, through the mixing up of sediments, through the adulteration of filtering systems, etc. Now, we take our water for granted. That will be dangerous after a big quake.

## HOW MUCH SHOULD I STORE?

A good rule of thumb is: **5 GALLONS PER PERSON (MINIMUM)**

*NOTE: Treat your pet as a family member when thinking about how much to store.*

## WATER SOURCES:

- Bottled Water from the Store - 1- and 2-gallon sealed containers (*NOTE: The 1- and 2- gallon containers you purchase in your local store are **not** designed for long-term storage and will begin to leak/fail after about 6 months.* )
- 1- and 5-Gallon Sealable Containers - From camping or survival stores. Be sure to sanitize container and treat the water that you are storing. Old bleach bottles, clearly marked, make good containers for water storage.
- 20-oz. to 1-Liter Designer Water Containers - Are usually marked with an expiration date, but are generally good for about two years
- 5-Gallon Water Bottles from Private Water Companies - Water companies claim their water and containers are good for up to five years, if still factory sealed & correctly stored in a cool dark location.



**DO NOT STORE ANY PLASTIC WATER CONTAINER DIRECTLY ON CONCRETE.**

*The concrete will leech chemicals into the water, contaminating it and also degrading the plastic bottle, causing failure.*

# PURIFYING YOUR TAP WATER

Store all plastic water containers on a wooden pallet or shelf. Keep water containers in a location where container failure will not destroy your other supplies. Keep all water and supplies in a cool dark place.

## GETTING THE WATER OUT OF YOUR WATER HEATER :

- Use extreme caution. Let the water cool.
- Turn off the cold water supply to the tank
- Turn off the gas or electric heater for the tank
- Open the drain valve at the bottom

Any water that you make up yourself needs to be treated. If left untreated over time, it becomes contaminated with bacteria and algae.

- 8 DROPS OF PURE UNSCENTED LIQUID BLEACH PER GALLON OF WATER WILL REDUCE THE CONTAMINANTS IN THE WATER.
- ADD THE BLEACH WHEN YOU FIRST STORE THE WATER AWAY.



### IF THE PURITY OF YOUR WATER SOURCE IS QUESTIONABLE, USE THE FOLLOWING METHODS TO MAKE THE WATER SAFE TO DRINK:

- BEST! Add Liquid Chlorine Beach to the water (8 drops per gallon of water. Double this dose if the water is cloudy.)  
OR
- GOOD! Add 2% Tincture of Iodine to the water (12 drops per gallon of water. Double this dose if the water is cloudy.)  
OR
- ACCEPTABLE! Boil the water vigorously (5 min. at sea level, adding an extra minute for every 1000 feet above sea level. Double this time if the water is cloudy.)  
AND
- Don't forget to clean and sanitize your food and water containers before using them. Wash with soap and water then fill with a 10% bleach solution. After 5 min. empty the bleach solution and let air dry  
AND
- Water that is dirty should first be strained through a coffee filter, cheesecloth, or a paper towel to remove suspended matter.

*REMEMBER: Some sediment at the bottom of the tank may at first make water flowing out look murky. Continue to drain water until it becomes clear.*

### OTHER SOURCES OF WATER IN YOUR HOME

- Toilet Water Storage Tank. NOTE: Use the water from the Storage Tank - NOT THE TOILET BOWL (Don't drink the water if you use coloring or chemicals in it)
- Melted Ice Cubes are a source of water
- Water-Packed Can Goods (even syrups are mostly water)
- Water Trapped In Home Piping. Water can be removed by locating and shutting off the main water valve. Then, open the valve at the highest point of your property (i.e., shower head, especially on the 2nd floor). Then, when you open the valve at the lowest point, gravity will force the water from the pipes.

**NOTE: ROTATE YOUR WATER EVERY SIX MONTHS** (This includes the 1- and 2-gallon sealed bottles purchased at the store, and the supply you made up from tap water with bleach added.)

Another source of water is the hot water heater. Every water heater has a drain valve near the bottom.

**THE PREVIOUSLY MENTIONED SOURCES ARE FOR DRINKING AND FOOD PREPARATION**

**DO NOT DRINK POOL OR SPA WATER! POOL WATER CONTAINS MANY TOXIC CHEMICALS AND HAS A HIGH POTENTIAL OF GIVING YOU DIARRHEA, CAUSING DEHYDRATION!**



# STRAPPING REQUIREMENTS FOR WATER HEATERS

Since the City of Los Angeles is in Seismic Zone 4, perforated iron strap (plumber's tape) will not be an acceptable method for strapping or bracing water heaters over 40 gallons. Water heaters over 40 gallons shall have Office of the State Architect approved straps, and shall be installed according to the manufacturer's installation instructions.

The State of California requires that all water heaters be strapped to resist motion during an earthquake. This may be accomplished by installing an over-the-counter "water heater restraint" kit which has been designed specifically for this purpose, and which has been accepted by the California Division of the State Architect (DSA). Such kits are available from plumbing hardware supplier. An Alternative method is shown below in Example 2, using heavy-duty metal strap material and hardware.

As per 1996 LAPC, Section 94.510.5, water heaters must be strapped in at least two locations, one being in the upper one-third of the unit, and the other in the lower one-third. The lower strap must be a minimum of 4" above the water heater control unit.

## Example 1 (side-to-side straps).

Drill pilot holes on centerline of stud (both sides of heater), insert screws through punched holes in strap. Use washers.

Stand required in garage locations as per sec. 94.510.1 LARC..

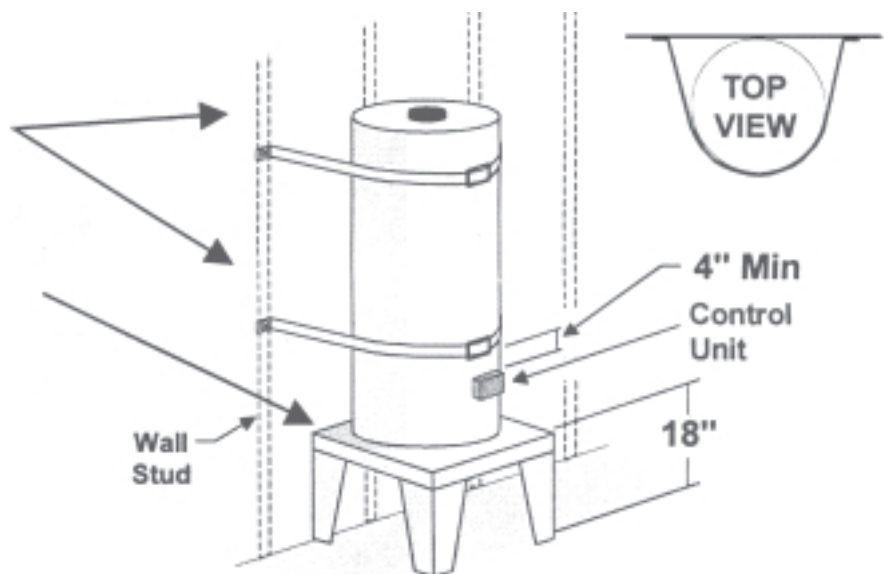

## Example 2 (wrap-around straps):

Drill pilot holes on centerline of stud (both sides of heater), insert screws through punched holes in strap. Use washers.

Use minimum 22 Gauge X 3/4" wide metal strap.

Stand required in garage locations as per sec. 94.510.1 LA.P.C.

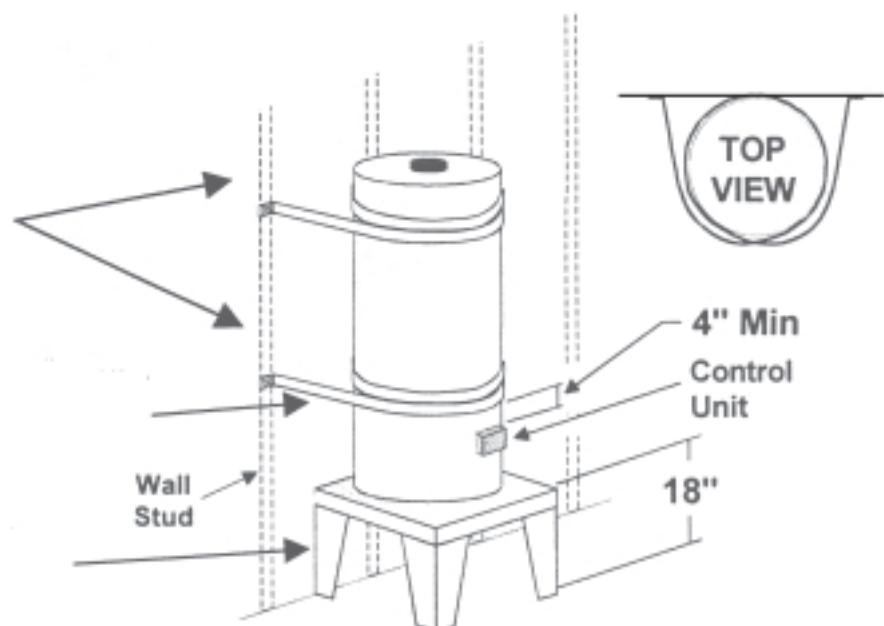



# STRAPPING REQUIREMENTS FOR WATER HEATERS

The installation must satisfy the water heater manufacturer's minimum clearance requirements, as stated on the unit nameplate.

Lag screws not less than 1/4" in diameter must be used to anchor the restraints to the wall, and each lag screw must have at least 1-1/2" thread penetration into a wall stud. A large flat washer must be installed between each lag screw and the strap for reinforcement.

Water heaters generating a glow, spark or flame capable of igniting flammable vapors may be installed in a garage, provided the pilots, burner or heating elements and switches are at least eighteen inches above the floor level.

All over-the-counter kits must be installed according to the manufacturer's instruction, and must also meet the conditions above.

Illustrated are generic examples of City of Los Angeles acceptable methods for restraining a water heater. These examples are not meant to exclude other approved designs:

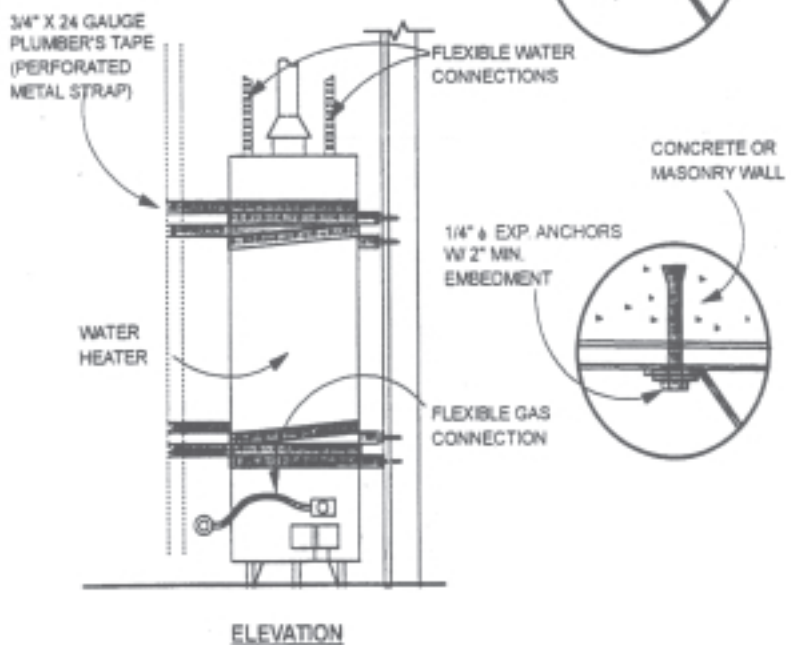
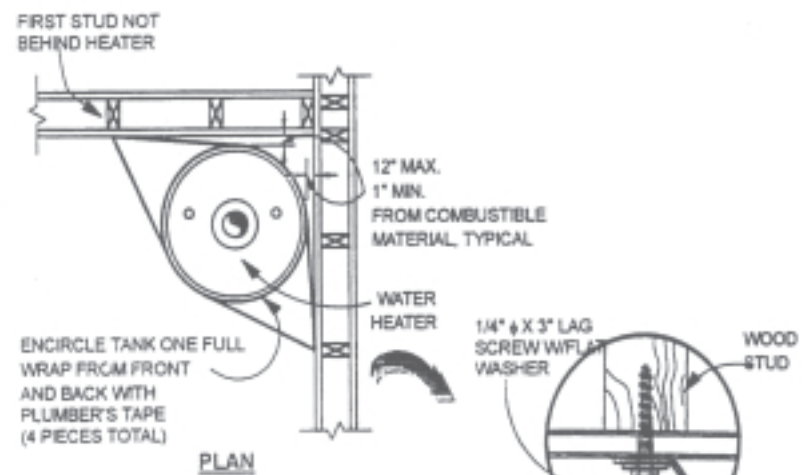
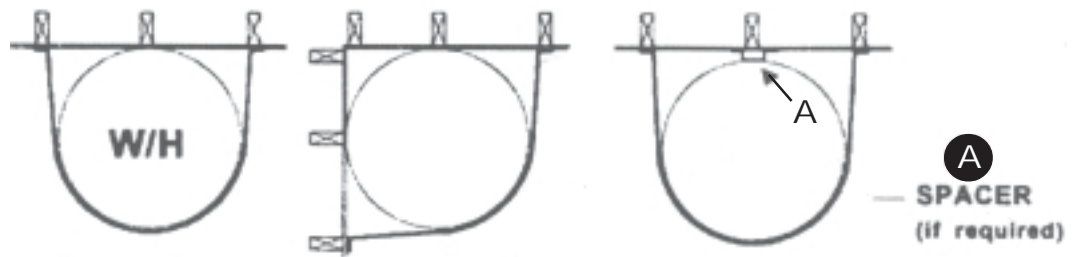

# PORTABLE/AUTO SURVIVAL KIT

OK, you've prepared your home. What about when you're away from home? In your Car or at Work?

Southern Californians spend a great deal of time in their vehicles. Our sprawling megalopolis necessitates the use of vehicles for even the simplest of errands. We also need to prepare ourselves while we are away from home. A portable survival kit kept in the car and another kept in our office will give us the ability to get along until we are able to return home.



## HERE IS A LIST OF ITEMS WHICH SHOULD BE KEPT IN YOUR CAR'S MOBILE SURVIVAL KIT:

- Nylon carrying bag or day-pack
- Bottled water
- Nonperishable food
- Can opener
- Transistor radio and EXTRA batteries
- Flashlight and EXTRA batteries
- Fire extinguisher (ABC-type)
- First aid kit
- Gloves
- Essential medication (if refrigeration is not required)
- Blanket, sleeping bag, space blanket
- Sealable plastic bags
- Pre-moistened towelettes
- Small toolkit
- Matches and lighter
- Walking shoes and extra socks
- Change of clothes
- Jacket
- CASH (small denominations and coins)

## HERE ARE ITEMS THAT CAN BE USED FOR A PERSONAL SURVIVAL KIT AT WORK

Your workplace kit should be small and portable. Place it into a small day-pack. You should be able to carry your supplies with you if your business is closed and you need to evacuate to another location. It should include:

- Dry Food - candy bars, dried fruits, jerky, cookies, crackers, etc.
- Drinks - water or juice
- Tennis shoes/walking shoes for office workers
- First aid kit with routine medications (aspirin, acetaminophen, cough/cold tablets, allergy tablets, etc.)
- Extra prescription medications
- Flashlight/batteries
- Chemical light sticks
- Matches
- Small radio (battery-operated portable)
- Small and large plastic bags
- Toiletries/personal hygiene items
- Entertainment Pack - Family photos, notebooks, literature, and games

*REMEMBER:  
You could be stranded for up to 72 hours. Make sure you have enough supplies to meet your needs.*





# EMERGENCY LIGHTING:

DON'T use matches, candles, or oil lamps, especially right after the quake. Aftershocks are coming and they could cause candles or oil lamps to fall, causing fires. Immediately after an earthquake there is the danger of natural gas or propane leaks and any source of flame could cause an explosion.

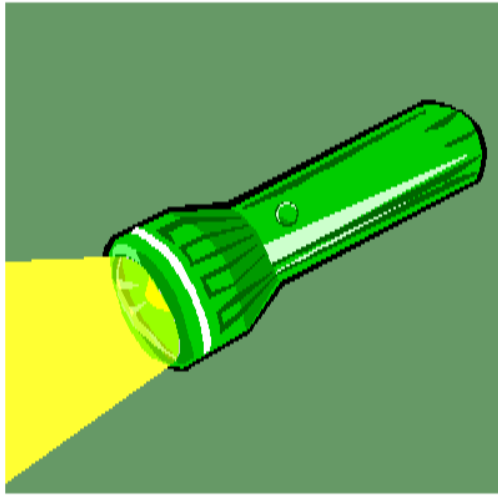

- Flashlight or battery-operated lantern for the home (plus EXTRA batteries and ROTATE them)
- Flashlight/penlight for personal use
- Power failure lights (the type left plugged into the wall)
- Chemical light sticks (very SAFE light source)
- Gas/propane lanterns (plus MANTLES, MATCHES, FUEL) protect these lamps from falling or being knocked over during aftershocks.
- Portable electric generator (plus FUEL). Remember, light requires little energy from a generator. A 200-watt light bulb will light a camp well enough to read by. Creating heat or cold require large amounts of electricity. Your hair dryer probably requires 1500 watts of output to

run. So purchase your generator with sufficient power for your needs. Or plan your appliances according to your generator's output.

# COOKING AFTER THE EARTHQUAKE:

Cold food for more than a few meals is unappealing. You need to try and eat as normally as possible after the disaster. This is for your physical as well as your mental health. Basically, you'll be on a camp-out for three or more days.

- Camp stove (Have plenty of propane or white gas)
- Backpacking stove
- FIREPLACE should not be used after an earthquake, until it has had a video inspection by a chimney specialist. Unseen damage may cause an attic fire or allow carbon monoxide into dwelling.
- Barbecue (Charcoal and starter fluid)
- Sterno (type) stove
- Cooking utensils
  - Pots
  - Pans
  - Cups & glasses
  - Forks and knives and spoons
- MANUAL CAN OPENER. To open all your cans of stored food.
- IMPORTANT SAFETY NOTICE:** Don't use any of these stoves indoors. Carbon monoxide poisoning can occur.



# EMERGENCY FOOD SUPPLY

Food is as important as water for post-quake survival. Psychologists tell us people who have experienced a severe emotional trauma may give up on life and can even die from the depression which follows.

Psychologically a normal and healthy diet can lessen the emotional trauma of a disaster. Therefore, we recommend that people store supplies for a disaster that are as close as possible to their normal fare. The food must be of a type that stores well. The minimum time that food should be able to last without refrigeration is 6 months.

In the brief space here it is difficult to give the information necessary to put together an emergency food storage program. The needs and tastes of individuals vary greatly. If you are a smaller or larger than average person you may want to adjust what you store as compared with what is suggested. The information here is to give the person who wants to store emergency food supplies some ideas. **IT IS NOT INTENDED AS A SHOPPING LIST OF THINGS TO BUY.** In each of the categories there is more food listed than should be needed. Think about the tastes and needs of your family.

## ROTATING SUPPLIES



Rotating supplies every 6 MONTHS is the key. Not because everything will go bad in six months. But, because you need to make rotating supplies part of your normal habits. The easiest way to remember to rotate is to change your supplies every time you change your clocks for "daylight savings time". Remember, when you ROTATE YOUR CLOCKS, you ROTATE YOUR SUPPLIES.

The easier it is for you to think about doing it, the more apt you are to do it continuously. When you rotate your supplies, don't throw them out, put them in the pantry and use them. Nothing has to go to waste.

REMEMBER: Your supplies rotation should include (but is not limited to), Batteries, Food, Water, Medications (prescribed and over-the-counter). Don't forget to check and shake that fire extinguisher while you're at it.

## SAMPLE FOOD ITEMS

You need to stockpile at least 7 DAYS WORTH OF SUPPLIES PER PERSON PLUS PETS. These supplies should be nonperishables with long shelf lives. They should also be stored in a cool, dry & dark place. Heat and moisture speed the spoilage of food.

The following is a list of a few sample items. This is by no means the complete list of foods to stock. You should keep items that you and your family will eat. Try and select items that you use daily in your home. If your kids won't eat canned tuna before the earthquake they certainly will not eat it after. Try to plan as if you're going on a camping vacation for 7 days, because this is essentially what you will be doing.

Remember to consume what you have in your refrigerator first, then your freezer, then your stored goods.



# SAMPLE FOOD STORAGE ITEMS

## BEVERAGES:

- Milk - dehydrated or evaporated
- Soda
- Coffee, teas, instant cocoa - Remember, drinks with caffeine in them will move water through your body faster, so you might consider storing 1/2 again as much water.
- Powdered beverages as desired - Don't forget these will require extra stored water to make.
- Fruit/tomato/vegetable juices
- Sport drinks, such as Gatorade

## GRAIN PRODUCTS:

- Multi-packages of individual serving breakfast cereal
- Instant HOT cereal in paper packages
- Pancake mix - Get the ones that require water only
- Bread (store in freezer)
- Pasta
- Flour
- Corn meal
- Soda crackers
- Rice



## PROTEIN SOURCES:

- Canned meat; bacon, Spam, sausages, meat spreads, chili con carne, beef stew
- Canned poultry; chicken, turkey
- Canned fish; tuna, salmon, sardines
- Cheeses (hard wax-wrapped cheeses last longer)
- Dried eggs

## FRUITS AND VEGETABLES:

- Canned berries
- Canned pears, peaches, apricots, plums
- Canned citrus fruits
- Canned vegetables
- Dry peas
- Instant mashed potatoes
- Dry package beans

## STAPLES:

- Salt
- Sugar
- Cooking oil
- Shortening
- Baking soda
- Honey



## SEASONINGS AND SPICES

- Include seasonings appropriate for the meals you choose to store. Spicy foods increase the consumption of fluids.

## SNACKS AND OTHER FOODS:

- Nuts
- Peanut butter
- Hard candy
- Dried fruit
- Jerky
- Dry soup mix
- Canned soup



# HOW TO SHUT OFF UTILITIES

## GAS SHUT-OFF

Locate main gas shut-off (usually outside house) at the gas meter. The valve is usually on a pipe coming out of the ground, going into the gas meter. Turn the valve crosswise to the pipe (see the large example on the "Utilities" page under "Before the Earthquake". All the pilot lights in and around your home (stove, furnace, clothes dryer, swimming pool/spa heater, water heater, etc.) will go out when you turn the valve off. You will need to have the gas company, or another qualified individual (plumber, contractor, or trained homeowner), relight every pilot when turning the gas back on. **Forgetting to relight all the pilot lights could result in a dangerous gas buildup in your home.** Remember, if you don't smell gas or have severe damage to your home you should not have to shut the gas off. It's your decision.

Clear the area around the main gas shut-off valve for quick and easy access in case of emergency.

A wrench (or specialty tool), for turning off the gas, should be attached to a pipe next to the shut-off valve or in another easily accessible location.

You may want to paint the shut-off valve with white or fluorescent paint so that it can be located easily in an emergency.

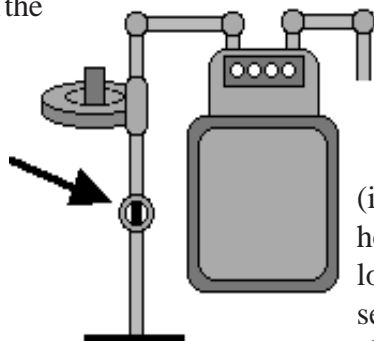

If you are concerned about your ability to turn off the main gas shut-off valve or are unsure if it is in proper working order (indication of rust, etc.) or do not know how to relight your pilot lights, contact your local gas company. They can send a service representative to your house to show you the proper procedure and check the valve and pilot lights to be sure they operate properly.

## AUTOMATIC GAS SHUT-OFF VALVES

Automatic gas shut-off valves are an excellent way to insure that your gas is shut off in the case of a major earthquake. They are recommended by the Fire Department. In many cities in California they are required to be installed when you sell your home or do more than a \$10,000 remodel. With an automatic valve your gas will be off even if you aren't home at the time. Contact your local gas company for more information and installation.

## ELECTRICAL SHUT-OFF

First locate all of your home's electrical panels. Note: There may be more than one.

Your house may be equipped with fuses or circuit breakers. If your house has fuses, you will find a knife switch handle or pullout fuse that should be marked "MAIN." If your house has circuit breakers, you may need to open the metal door of the breaker box to reveal the circuit breakers (never remove the metal cover). The main circuit breaker should be clearly marked showing on and off positions.

**Remove all the small fuses or turn off all the small breakers first, then shut off the "main."** If you have any sub-panels adjacent to the main fuse or breaker panel or in other parts of the house, in an emergency be safe and shut them off too.

Shorts can sometimes develop that cause a circuit to bypass the breaker or fuse.

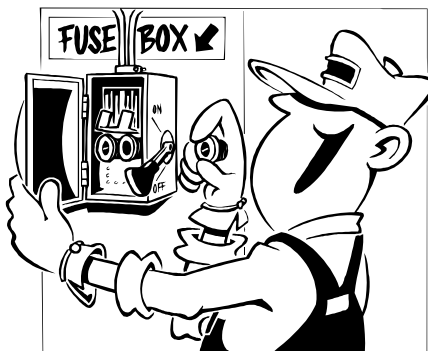

Note: All responsible family members should be shown how to turn off utilities in case of emergency. They need to know what the utilities look like in both on and off positions.

# UTILITIES

There is no cost involved in teaching everyone in your home about how & when to turn off the gas, electricity, and water after an earthquake. This can be as simple as clearly marking where the shut-off valves are, and posting instructions close by. Below are some common examples of shut-off valves. Even if you have something different, like a propane tank, the shut-off will be similar. If you cannot find the shut-off valves, or you do not understand the valve system, call your local utility company or tank provider. **Remember, consider shutting off utilities if you can smell gas, smell or see fire, or see damage to, from, or near the utility lines. It is wise to shut off utilities if you are going to leave the home for extended periods of time. This is because of the probability of aftershock.**

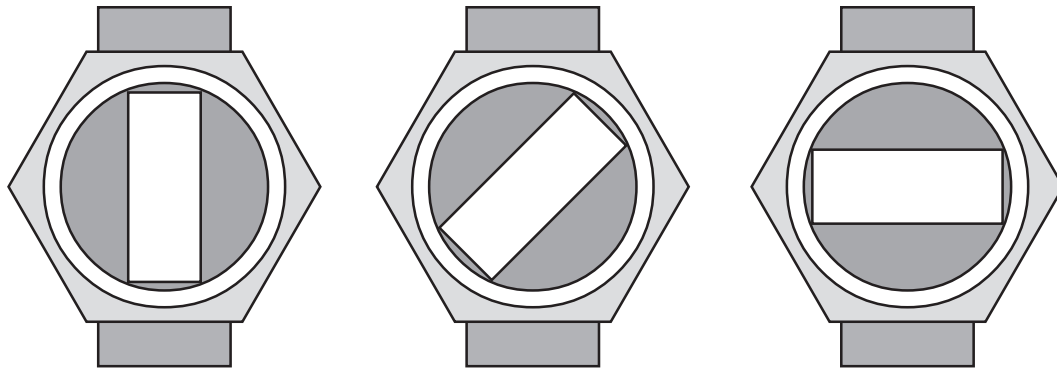

Gas ON

Test Gas Valve  
*TURN 1/8 TURN*

Gas OFF

## ***BEFORE AN EARTHQUAKE...***

- **TEST YOUR GAS VALVE:** Locate and identify your gas meter and main shut-off valve with those persons you believe could and should know how to shut off your gas if necessary. Identify the master shut-off valve. Paint the valve bright red. Note: Caution, there may be more than one shut-off on your meter.
- Use the illustrations of gas meter (pg. 18) and main shut-off valves (above) to help you identify yours.
- Using a 12" adjustable, or other appropriate wrench, turn the main valve 1/8 of a turn only to the right or left. (*This movement may be difficult at first*)
- **CAUTION:** Be careful, do not to turn any valve MORE than 1/8 turn to the right or left when testing. (If you do, pilot lights will very likely go out and it will require a trained person to relight them.)
- After you have moved that valve to ensure that it works, **KEEP THE WRENCH AT THE METER**, use plastic "zip ties" or straps to secure it to your meter.
- If you use an adjustable wrench be sure to store it pre-fit to your valve. That way in case it rusts or corrodes it will still fit. Heavy oil or grease applied to the moving parts of the wrench, before you secure it, will help keep it functional and ready for use. *Do not buy any plastic or fiberglass gas wrenches. They become brittle with time.*

***IF THE MAIN VALVE WILL NOT TURN 1/8 TURN, THEN CALL THE GAS COMPANY IMMEDIATELY AND THEY WILL COME OUT AND FIX OR REPLACE IT***



# HOW TO SHUT OFF UTILITIES *CON'T.*

## WATER SHUT OFF

Locate the main water service pipe into your house (probably in the front at the basement level). You will see a gate valve on the pipe. If you know you have leaks after an earthquake, you can shut off all water in your house with this valve. You may wish to paint the valve so it is easy to find in an emergency.

You can shut off all water to your property by finding the water meter box (usually at the street or sidewalk). Open the cover with a long screwdriver or specialty tool. If this box is inaccessible or you cannot find it, call your local water department. Be sure to

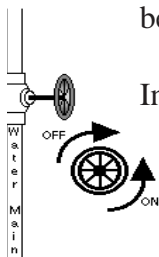

identify this box and the water valve inside before the need to use them arises.

Inside the water meter box you will see a valve that is similar to the valve on your gas meter. Turn it just the same as your gas valve.

---

## AFTER THE EARTHQUAKE

### TURN OFF YOUR GAS AT THE GAS METER SHUT-OFF VALVE. . . .

- ✦ If you smell, hear, or even suspect gas is escaping in your damaged or undamaged building(s).
- ✦ If your gas water heater or any other gas appliance has been knocked over and/or pulled free from its wall connection.
- ✦ If your building has suffered extensive damage, such as large cracks in the walls or in the concrete slab floors, etc. AND you suspect the gas lines may have been damaged.
- ✦ If you smell smoke and/or see or suspect fire

**NOTE:** If you have none of the above you are probably OK leaving your utilities on.

**NOTE:** Many gas companies have training programs to teach you how to turn your gas back on. Contact your local company for information.

**WARNING . . .** If you smell gas don't turn on or off any switches. Don't use any open flame to check for leaks. Don't turn on any battery operated flashlights, unless they are a safety/waterproof light. Chemical light sticks are a safe source of light in the event of gas leak.

**WARNING . . .** It is very dangerous and therefore not recommended that you go searching for gas leaks inside any damaged building.

**BE AWARE:** After an earthquake, aftershocks will continue to occur, possibly causing additional damage (or even first damage) to your building(s).

**REMEMBER:** Do not turn the gas valve back on after an earthquake, unless a qualified person has checked extensively for gas leaks.

**REMEMBER:** A qualified person (plumber, contractor, or trained homeowner) or gas company employee will have to relight all the pilot lights.

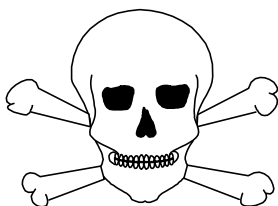

**DANGER**





# SECURING HEAVY FURNISHINGS

## NON-STRUCTURAL HAZARD MITIGATION - HOME

In California we are counseled by the experts not to run outside our buildings during an earthquake. This is because we are not as likely to see total structural failure as in other countries. Our wood frame homes generally do very well in earthquakes. Strict building codes reduce the risk of structural failure in our modern (post-1935) masonry buildings. Our greatest risk of injury during an earthquake is from non-structural hazards. Falling decorative pieces, fixtures, and heavy furniture account for a large percentage of the injuries.

Non-structural hazard mitigation is one of the least expensive ways to decrease the incidence of injury. Here are a few of the identified hazards and some suggested solutions.

### WINDOW AND MIRROR GLASS

Sharp shards may fall or be thrown across a room. Consider safety glass, wire glass or solar/safety film. The solar/safety film has the advantage of improving the insulating factor of the window. The energy saving may pay for the cost of the film. There are cost-free protective measures that you can use if the glass where you are is not safety type. You can pull down and close shutters or draw drapes. Even blinds that are pulled down, but not closed, offer some additional protection from flying glass.

### HEAVY FURNITURE

Furniture will move and fall during many types of disasters, especially tall, top-heavy items. Secure the furniture to the wall. Use braided metal cable, chain, or angle brackets to secure all furniture to a wall anchor. Most often a wall anchor is an appropriately sized eyescrew. Be sure you screw wall anchors into a stud (A *stud* is the vertical, 2 x 4 in., wood post that supports your wall. They are normally spaced at 16 in. intervals.). Use of an inexpensive electronic stud finder makes the job much easier with less damage to your walls. Screws should always be used, never nails. Nails will pull out during a large earthquake.

### GAS APPLIANCES

Your stove, water heater, furnace, clothes dryer, etc. may run on natural gas or propane. Unsecured gas appliances may crush someone or rupture their gas feed line during a quake. If these objects move or topple the resulting gas leak may destroy your home, a home which would otherwise have survived with only minor damage. Secure all gas appliances to a wall stud and use flexible gas lines. The flexible gas line should be longer than necessary to allow for some movement. The appliance should be secured top and bottom to prevent tipping, rolling and sliding. Use heavy plumber's tape or braided cable to secure your water heater to the studs in the wall. See "Securing Your Water Heater"

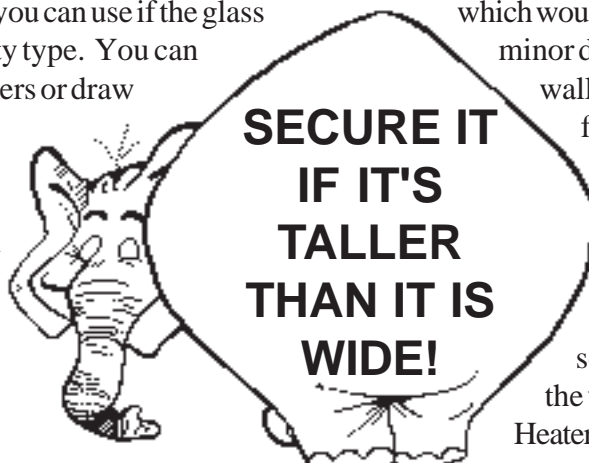

### REFRIGERATORS

Refrigerators are extremely heavy and most of them are on wheels. Because of their weight they may crush someone if they move and tip. Secure refrigerators, top and bottom, to insure they remain in place and upright during any earth movement. Use commercially available adhesive straps. Fasten one end into a wall stud and adhere the strap securely to a structural component of the refrigerator. Do not secure anything to the coils in the rear of the box. These are made of lightweight material and will not support the weight of the unit. Follow manufacturer's directions.

# **SECURING HEAVY FURNISHINGS** *CON'T.*

## **HANGING PICTURES, MIRRORS, CLOCKS ETC.**

Anything simply hanging on a wall will come flying off in a large shake. Use an appropriately sized eyebolt and a hollow wall anchor for lighter items. Larger items will require an eyescrew that is screwed into a wall stud.

## **DECORATIVE ITEMS AND BRIC-A-BRAC ON SHELVES, BOOKCASES, ETC.**

Unsecured objects will fall during a shock. Run a wire, monofilament fishing line, or guardrail across the shelf front. (The line/rail should be placed 1/3 the height of the shelf, from the bottom.) Objects can be secured in place with Velcro, 2-sided tape, porcelain glue. Place large or heavy objects on the bottom shelf. Heavy items can be secured with industrial strength Velcro.

## **CUPBOARD ITEMS**

Cupboards will open and spill their contents during a quake. Put heavy items on bottom shelves and use positive latches to prevent doors from opening.

## **FLAMMABLE LIQUIDS**

Spilled flammable liquids may cause fire and destroy a home that would have survived undamaged. Store all flammable liquids outside, in their original/proper containers, away from structures and vehicles. If you must store flammable liquids in your home store them in the garage, keep them in a cabinet with locking doors, and always store them on the lowest shelf. See "Hazardous Materials" Section.

## **BEDS LOCATED NEAR WINDOWS**

Plate glass may break during a disaster. Relocate beds away from windows and tall heavy furniture. Apply safety film to all windows where people live or work.

---

---

## **NON-STRUCTURAL HAZARD MITIGATION FOR BUSINESSES**

Good employees are your most valuable asset. Protect them with a safe working environment.

## **EQUIPMENT AND FURNISHINGS**

- Strap rows of multiple file cabinets, mainframes, book cases, etc. together. High racks should be secured together on top and to the floor on the bottom.
- Secure desktop computers, typewriters.
- Keep computer CPUs on the floor next to their work stations.
- Secure cabinet doors with positive latches.
- Store hazardous materials correctly and educate all your employees about them.
- Secure freestanding, moveable partitions.

**SECURE  
ANYTHING  
HEAVY THAT IS  
AT OR ABOVE  
DESKTOP LEVEL**



**USE 2" SCREWS TO FASTEN HEAVY OBJECTS TO WALL "STUDS."**

**DON'T USE NAILS, THEY PULL OUT.**

**DON'T USE "HOLLOW WALL ANCHORS."**

# SECURING HEAVY FURNISHINGS *CON'T*

## OVERHEAD

Seen and unseen objects overhead and above suspended ceilings may pose hazards to workers below. Secure all objects that are above desktop level.

- Check for diagonal bracing wires in suspended ceilings.
- Ensure proper restraint of “stem” light fixtures and fluorescent light panels.
- Securely attach decorative ceiling panels, spotlights, speakers, air conditioning units, etc.
- Check above suspended ceilings for poorly attached ducts, cables, etc.

## ELECTRICAL EQUIPMENT

Shock hazards exist if unsecured electrical equipment breaks its connections or exposes energized lines. Unsecured equipment may short out the power in your office or building.

- Secure any electrically powered equipment
- Have backup power generators for emergency lighting and to protect computers against data loss. Ensure that generators, their fuel tanks, battery packs, and fuel lines are properly secured.
- Secure emergency lighting.
- Secure telecommunication equipment, switches, and control boxes.

## PLANT EQUIPMENT

Loss of plant equipment may prevent you from continuing your business after a quake.

- Secure water heaters, furnaces, boilers, fans, pumps, heating, ventilating, air conditioning equipment, and the ducting or pipes that go with them.



## HAZARDOUS MATERIALS

Unsecured or improperly stored hazardous chemicals may force your business out of an otherwise undamaged building.

- Secure large containers of production chemicals or cleaning supplies.
- Ensure that all toxic items are in the correct containers and properly labeled.
- Ensure that all employees know what to do in case of a spill.
- Keep all large containers or vats of toxic, hot, or hazardous items covered to prevent surging in an earthquake.

## EMPLOYEES

- Establish an education and awareness program for work and home. Encourage family involvement.
- Encourage employees to be prepared at home and work.
- Give each employee specific instructions as to areas of responsibility before, during, and after a disaster.
- Establish a good safety program. Keep the employees continuously informed regarding hazards, safety warnings, emergency plans, and supplies.

## NEIGHBORS

- Find out what your business neighbors do. Their enterprise may put your business in greater jeopardy and you may need to plan for problems related to their potential problems.

# HELPING CHILDREN COPE

Children may be especially upset and exhibit exaggerated emotions following the disaster. These reactions are normal and usually will not last long.

## ***LISTED BELOW ARE SOME PROBLEMS YOU MAY SEE IN YOUR CHILDREN:***

- Excessive fear of darkness, separation, or being alone
- Clinging to parents, fear of strangers
- Worry
- Increase in immature behaviors
- Not wanting to go to school
- Changes in eating/sleeping behaviors
- Increase in aggressive behavior or shyness
- Bed-wetting or thumb-sucking
- Persistent nightmares
- Headaches or other physical complaints



## ***SOME THINGS THAT WILL HELP YOUR CHILD ARE:***

- Talk with your child about his/her feelings about the disaster. Share your feelings, too.
- Talk about what happened, give your child information he/she can understand.
- Reassure your child that you are safe and together. You may need to repeat this reassurance often.
- Hold and touch your child often.
- Spend extra time with your child at bedtime.
- Allow your child to mourn or grieve over the lost toy, a lost blanket, or a lost home.
- If you feel your child is having problems at school, talk to his/her teacher so you can work together to help your child.

Please reread this in the coming months. Usually a child's emotional response to a disaster will not last long. But some problems may be present or recur many months afterward. Your community mental health center is staffed by counselors skilled in talking with people experiencing disaster-related problems.

***IF YOU WOULD LIKE FURTHER INFORMATION PLEASE CALL:  
LOS ANGELES COUNTY DEPARTMENT OF MENTAL HEALTH***

**24-hour (800) 854-7771 (TTD only) (562) 651-2549**



# ADULT COPING WITH DISASTERS

Having just experienced the shock and pain of a disaster, you will be very busy for the next few days or weeks. Caring for your immediate needs, perhaps finding a new place to stay, planning for cleanup and repairs, and filing claim forms may occupy the majority of your time. As the immediate shock wears off, you will start to rebuild and put your life back together. There are some normal reactions we may all experience as a result of a disaster. Generally, these feelings don't last long, but it is common to feel let down and resentful many months after the event. Some feelings or responses may not appear until weeks or even months after the disaster.

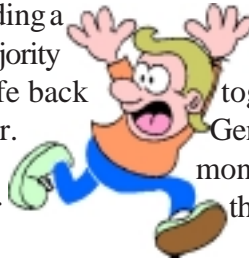

Some common responses are:

- Irritability/Anger
- Sadness
- Fatigue
- Headaches or nausea
- Loss of appetite
- Hyperactivity
- Inability to sleep
- Lack of concentration
- Nightmares
- Increase in alcohol or drug consumption



Many victims of disaster will have at least one of these responses. Acknowledging your feelings and stress is the first step in feeling better. Other helpful things to do include:

- Talk about your disaster experiences. Sharing your feelings rather than holding them in will help you feel better about what happened.
- Take time off from cares, worries and home repairs. Take time for recreation, relaxation or a favorite hobby. Getting away from home for a day or a few hours with close friends can help.
- Pay attention to your health, to good diet and adequate sleep. Relaxation exercises may help if you have difficulty sleeping.
- Prepare for possible future emergencies to lessen feelings of helplessness and bring peace of mind.
- Rebuild personal relationships in addition to repairing other aspects of your life. Couples should make time to be alone together, both to talk and to have fun.



If stress, anxiety, depression, or physical problems continue, you may wish to contact the post-disaster services provided by the local mental health center.

Reread this periodically over the next few weeks and months. Being aware of your feelings and sharing them with others is an important part of recovery and feeling normal again soon.



# EMERGENCY COMMUNICATIONS

## TELEPHONE COMMUNICATION

After a major disaster most of our normal methods of communication will be interrupted. Telephones will be out, the mail won't be delivered (you may not have a home to deliver it to), or you may be isolated at work and unable to travel to your family.

Immediately after an earthquake, your phones will probably will not work. This could be because of damage to switching centers, local phone lines, and trunk lines. It could be that power to operate the phone system itself is unavailable.



The number one cause of phone failures is too many phones off the hook at one time. Many will be off the hook because they were knocked over in the shock, but a larger number will be because everyone is trying to call friends and family. This overload can damage the phone companies' switching systems. To prevent this damage, whole sections will shut down automatically when a certain percentage of phones are off the hook.

It's normal to want to check on your family, or let family know you're OK. But, we need to limit our calls if we want the system to work at all. The solution to this problem is to have **one** out-of-state contact for all your family members. This way all your relatives and friends will not be tying up the phone lines trying to get you, and you them. Long distance lines do not go down from too many calls or phones falling off the hook. Another advantage is that if an earthquake shuts down the long distance lines, these lines will be one of the first lines returned to service. You will be able to reach someone out of state before you could reach someone next door.

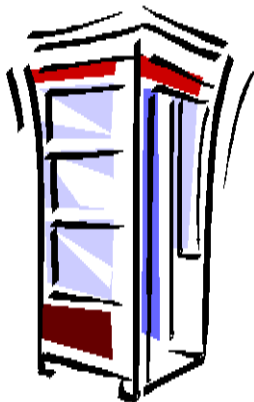

We recommend that you go to a pay phone to make your calls. These lines will be put in service before residential lines. Plus the load on phone lines is less late at night or early in the morning. A pay phone, calling long distance, early in the morning is your best chance for communicating.

When you reach your out-of-state contact **KEEP IT SHORT** and quick. The phone system may go out again at any time. Give your condition and the condition of the family members you know about. Get information on members who are not with you. Tell them you'll call them to chat in a few days. Then say good-bye and hang up.

The next page contains some "Out-Of-State Contact Cards" for you to fill out. Give them to all your family and friends. Xerox extras if needed. This system has proven that it works in previous California earthquakes.

## CELL PHONES

Cellular telephones are really radios on a network. They can't talk to each other, but must use a cell site to connect calls. It is recommended that if you plan to use cell phones to communicate after a disaster that they be on the same network or service provider system as the people you want to talk to.



## HAM RADIO COMMUNICATION

Ham radio is a mainstay of disaster communications. The FCC has recently lowered the requirements to become a licenced HAM. To become a HAM contact your local radio clubs listed in the yellow pages.

The Los Angeles City Fire Department uses HAMs for communication and coordination of CERT (Community Emergency Response Team) volunteers.

The LAFD ACS NET:

(Meets On-air Mondays 1930-2000)  
2-Meter, 147.300 , PL110.9, +600 146.58 Simplex



# EMERGENCY CONTACT CARDS

1. Call a friend or relative who lives outside the state and ask them to be your family's "out-of-state contact".
2. Explain to them that after a disaster they will be your surest means of communicating with other family members, both in and out of state. Make sure that they understand that it will be their responsibility to be available to take calls immediately following a disaster in your area.
3. Agree to do the same for your contact in case disaster should strike their state.

4. Notify all your friends and family members that this one person will be the person to contact if they need to get a message to you. Tell them not to call direct.

5. Completely fill in the contact card. It should be typed or printed in ink and then "plasticized" to protect it from wear and water.

6. Have each member of your family carry this card at all times. Xerox this page so that you can have spare cards in cars, lunch pails, taped to the bottom of your phone at work, etc.

7. Have family members in other areas or states agree on the same out-of-state contact for any family emergency. Plan for an alternate contact in case disaster strikes in the area where your emergency contact lives.

EMERGENCY OUT-OF-STATE CONTACT		
NAME	PRIMARY CONTACT	PHONE
	( )	
NAME	ALTERNATE CONTACT	PHONE
	( )	
ADDRESS		
CITY	STATE	ZIP

EMERGENCY OUT-OF-STATE CONTACT		
NAME	PRIMARY CONTACT	PHONE
	( )	
NAME	ALTERNATE CONTACT	PHONE
	( )	
ADDRESS		
CITY	STATE	ZIP

EMERGENCY OUT-OF-STATE CONTACT		
NAME	PRIMARY CONTACT	PHONE
	( )	
NAME	ALTERNATE CONTACT	PHONE
	( )	
ADDRESS		
CITY	STATE	ZIP

EMERGENCY OUT-OF-STATE CONTACT		
NAME	PRIMARY CONTACT	PHONE
	( )	
NAME	ALTERNATE CONTACT	PHONE
	( )	
ADDRESS		
CITY	STATE	ZIP

EMERGENCY OUT-OF-STATE CONTACT		
NAME	PRIMARY CONTACT	PHONE
	( )	
NAME	ALTERNATE CONTACT	PHONE
	( )	
ADDRESS		
CITY	STATE	ZIP

EMERGENCY OUT-OF-STATE CONTACT		
NAME	PRIMARY CONTACT	PHONE
	( )	
NAME	ALTERNATE CONTACT	PHONE
	( )	
ADDRESS		
CITY	STATE	ZIP

EMERGENCY OUT-OF-STATE CONTACT		
NAME	PRIMARY CONTACT	PHONE
	( )	
NAME	ALTERNATE CONTACT	PHONE
	( )	
ADDRESS		
CITY	STATE	ZIP

EMERGENCY OUT-OF-STATE CONTACT		
NAME	PRIMARY CONTACT	PHONE
	( )	
NAME	ALTERNATE CONTACT	PHONE
	( )	
ADDRESS		
CITY	STATE	ZIP

**This page intentionally left blank.**



# SPREAD THE NEWS ABOUT THIS FREE PROGRAM OFFERED BY THE LAFD TO THE CITIZENS OF LOS ANGELES!

To contact us phone: (818) 756-9674, Fax: (818) 756-9681



E-Mail:  
lafdcert@bigfoot.com



**Snail-Mail:**  
**COMMUNITY EMERGENCY RESPONSE TEAM PROGRAM**  
Los Angeles City Fire Department, Disaster Preparedness Unit  
5021 North Sepulveda Boulevard, Sherman Oaks, CA 91403

## COURSE SYLLABUS

### CLASS 1 - INTRODUCTION, EARTHQUAKE AWARENESS

Registration, Introduction, Earthquake Threat in So. California, Personal & Family Preparation, Nonstructural Hazard Mitigation



### CLASS 2 - DISASTER FIRE SUPPRESSION TECHNIQUES

Fire Chemistry, Fire Extinguisher Use, Utility Control, Ventilation, Creative Firefighting Techniques, Hazardous Materials



### CLASS 3 - DISASTER MEDICAL OPERATIONS (SESSION 1)

Recognizing & Treating Life-Threatening Emergencies, Triage, Treatment Area Management



### CLASS 4 - DISASTER MEDICAL OPERATIONS (SESSION 2)

Head-to-Toe Evaluation, Recognizing & Treating Non-Life-Threatening Emergencies



**CLASS 5 - LIGHT SEARCH & RESCUE OPERATIONS** Evacuation, Search Techniques, Rescue Methods



### CLASS 6 – TEAM ORGANIZATION & MANAGEMENT

Developing a Response Team, Incident Command System, Size-Up, Disaster Psychology



### CLASS 7 – COURSE REVIEW & DISASTER SIMULATION

Disaster Simulation Critique



The Los Angeles City Fire Department's CERT Program was developed because of the need for a well-trained civilian emergency work force. These teams will assist the government by responding during disaster situations where the number and scope of incidents have overwhelmed the conventional emergency services. The training program provides for community self-sufficiency through the development of multifunctional response teams who will act as an adjunct to the city's emergency services during major disasters. Through this unique program, people from community organizations, business and industry, and city employee groups will become members of CERT, or perform as individual leaders by directing untrained volunteers in the initial phase of an emergency. The CERT members receive 17-1/2 hours (one day a week for seven weeks) of initial training. The seven-week course is followed by continuing education programs, consisting of full-day biannual refresher drills and quarterly 2-1/2 hour refreshers. The ability of a business or community to effectively recover from the devastating effects of an earthquake requires the active participation, planning, and cooperation of all levels of the population. The fundamental responsibility for preparedness, however, lies with every individual. By encouraging preparedness efforts and hazard mitigation, the effects of a disaster can be minimized considerably. The benefits of this program are numerous. It has increased our overall level of disaster readiness, provided emergency skills that people may use in day-to-day emergencies, enhanced the bond between government and community, increased community spirit, and improved the quality of life for the people of our city.

## INFORMATION BULLETIN NOTICE TO PROPERTY OWNERS

### SEISMIC GAS SHUT-OFF VALVE REQUIREMENTS

Revised: January 1, 2001

The Los Angeles City Council has passed Ordinances which require seismic gas shut-off valves to be installed on certain buildings within the City. Seismic gas shut-off valves are devices designed to automatically shut off the supply of natural gas to a building to prevent a fire or explosion due to accumulation of gas within the building in the event of a major earthquake.

The provisions of this Ordinance apply to:

- New buildings built after September 1, 1995.
- Commercial buildings performing additions, alterations, or repairs with a building permit having a valuation of greater than \$ 10,000, issued after September 1, 1995.
- Residential buildings performing additions, alterations or repairs with a building permit having a valuation of greater than \$10,000, issued after January 10, 1998.
- All buildings sold in the City of Los Angeles after February 5, 1998. (Seismic gas shut-off valves must be installed within one year from the date of sale.)

The seismic gas shut-off valve may be installed on the customer side of the meter, this installation requires a Plumbing Permit and inspection from the Department of Building and Safety. A Plumbing Permit may be obtained by an owner/occupier of a single family dwelling. A Plumbing Permit may be obtained by a licensed Plumbing Contractor for any type of building. The cost of a Plumbing Permit for a single valve is \$43.40. To request an inspection, call 1-888-LA-4-BUILD (1-888-524-2845).

The valve may be installed on the Gas Company side of the meter by the Gas Company or a contractor authorized by the Gas Company. Valves installed on the Gas Company piping do not require a permit or inspection by the Department of Building and Safety.

#### ANSWERS TO FREQUENTLY ASKED QUESTIONS

- **How can I obtain a copy of this ordinance?**  
A copy of City Ordinance # 171874 can be obtained from the Los Angeles City Clerks' Office by calling (213) 485-5705. There is a charge of \$1.00 per request and \$.10 per page.
- **Do all property owners have to comply with this ordinance?**  
No. Only those properties located in the City of Los Angeles and within the jurisdiction of the Department of Building and Safety.
- **Does the City of Los Angeles recommend any seismic gas shut off valves.**  
No. Valves installed within the City must be approved by the Los Angeles Mechanical Testing Laboratory. See list on page 2.
- **Where can valves be purchased?**  
From supply retailers, plumbing contractors, or the valve manufacturers listed on page 2.

# APPROVED SEISMIC GAS SHUT-OFF VALVES

The following is a list of valve manufacturers, and their phone numbers, currently approved for use in the City of Los Angeles.

Manufacturers are listed by Research Report number:

Safe T Quake Corporation	4996	(800)786-7347 (818)407-4095	Quake Defense, Inc.	5413	(800)969-1906
Pacific Seismic Products, Inc.	5080	(800)442-7633 (661)942-4499	Trembler-Tech, Inc.	5475	(800)755-2621 (209)527-4143
Little Firefighter	5349	(888)340-3080 (714)834-0410	Seismic Valve Co. Inc.	5484	(714)963-6891
Seismic Safety Products	5370	(800)948-3782	Gasguard Technologies	5520	(888)397-4427 (310) 546-8133
Vanguard Valves, Inc.	5390	(800)718-7467	Security Environments	5529	(888)FLAME2000 (888)352-6320
Seismic Sentry Systems, LLC	5413	(877) 777-9543			

**Question: What if I buy a condominium in a building with multiple units?**

Answer: In condominium buildings the ordinance requires that the entire building be protected by seismic gas shut off valves within one year of sale.

**Question: What do I do if my building does not have a natural gas piping system?**

Answer: Please fill out the form below and mail it to the address listed.

**Question: My property went into escrow because of a refinance but there was no change in ownership. Is valve still required?**

Answer: No. The valve is only required when there is a change of ownership. If a notice was received because of a refinance please **XEROX this page** then fill out the form below and mail to:

Department of Building and Safety  
 Seismic Gas Shut-Off Valves  
 201 N. Figueroa St. Room 830  
 Los Angeles, CA 90012

**Seismic Gas Shut - Off Valves**

I certify that the address listed below:

Had no change of ownership after February 5, 1998

Has no gas to the building

Name: \_\_\_\_\_ Phone: \_\_\_\_\_

Address \_\_\_\_\_

Signature \_\_\_\_\_

# TYPES OF FIRE EXTINGUISHERS



UNDERWRITERS  
LABORATORY

Each extinguisher is required to have a label from the Underwriters Lab., or Factory Mutual Testing Lab. The Underwriters Laboratory labels are identified by the letters UL in a circle. Once you find the label look for the word "classification."

On the right side or just below this, you will see a series of numbers and letters. For example you may see "2-A:10-BC." Remove the numbers and what you have are the letters "ABC", this is the designation of the class of fire(s) the unit is to be used on. The numbers may be different but you still read them the same, i.e., 60-BC would be for class B & C fires only.

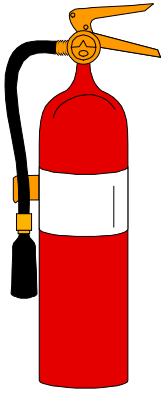

## Classifications of Fires

"A"-type fires are common combustibles, i.e., wood, paper, cloth

"B"-type fires are flammable liquids, i.e., gas, oil, grease

"C"-type fires are electrically energized fires, i.e., computers, toasters, heaters, appliances

## WATER - TYPE

Stainless steel, weighs about 35 lbs., holds 2 1/2 gals., it will reach up to about 35 ft., and will last approx. 1 minute. Class "A" only. It cannot be used on electrical or flammable liquid fires. This type works better as a spray by putting your finger over the end of the nozzle.

## DRY CHEMICAL - RECOMMENDED

The best general purpose extinguisher. Comes in "BC" or "ABC" (multipurpose). Available in different sizes. It has a range of 8 to 12 ft. It will empty in 10 to 20 seconds. This is an excellent choice for home use. It can be messy when used, but it is nontoxic. We recommend all homes have at least two dry chemical-type fire extinguishers (at least one per floor) with a minimum size rating of **2A-10BC**, including an earthquake restraining strap, a hose-type nozzle, and a metal head.

## CARBON DIOXIDE (CO2)

These are "BC" only. It is a gas that smothers the fire. They do not have a gauge. They reach about 2 to 5 ft., you have to get fairly close to the fire. For that reason always give a test shot before committing to the fire. Do not hold the cone-shaped nozzle because it may freeze to your hand.

## HALON - TYPE

These are also "BC" only. They come in various sizes. They are used in specialized applications involving electronics and aircraft. Older types are illegal to refill because of ozone depletion. Newer formulas are becoming available.



## For Fire Extinguisher Operation

### Remember

P  
A  
S  
S

Pull the pin

Aim at the base of the fire

Squeeze the handle

Sweep the fire



# FIRE SAFETY

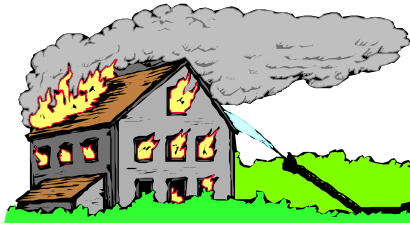

Fires can occur day or night. In the daytime they may appear to be deceptively small and easily controllable. At night, fire becomes a swift terror, worse than any nightmare.

Fires remain small and grow slowly for only a short time. After that, a fire can become a rolling inferno, moving through your home in moments. During the first five minutes, a small fire can preheat the ceiling materials of a room to over a thousand degrees. At this temperature, materials commonly found in a home begin to break down and release vapors. Some vapors coming from these materials at this point in the fire are as flammable as gasoline vapors. When the room becomes rich enough with vapors, the fire will move across the room in one rapid sweep. It only takes a couple of seconds under these conditions for the fire to change from the small incipient stage to a fully involved room. This is called "flashover". In a 10 by 10-foot room, it may happen in as little as two minutes. People can become trapped because they don't realize how fast the situation can change.

Once a fire flashes over in a room, it will begin to spread rapidly throughout the building. The number and location of open doors will directly affect the speed and direction the fire will take. Heated gases created by the fire will be forced from the room rapidly because they are expanding. In fire tests these gases have been seen to carry the fire down the hall at a rate of a hundred feet in ten seconds. This deadly speed is only possible when doors are nonexistent or are open. Closing any door in the path of the fire slows its spread for a time. How much time depends on the material and the construction of the door. Ordinary room doors will confine a fire for three to five minutes. Sometimes that confinement can last longer.

## *UPON DISCOVERY OF A FIRE*

**GET OUT!** Fire Safety in the home means, with few exceptions, complete evacuation of the home.

Close the doors. Do not fight the fire unless it is to save a life. By closing the door, you confine the fire and slow its spread. With the door closed the fire may be confined to a single room. If possible, close the doors to other rooms on your way out to give added protection.

**Notify!** Once you are outside, call the Fire Department. Dial 911 from a neighbor's phone and be prepared to provide the address, nearest cross street and a call back phone number. (The phone you are calling from). Don't hang up before the dispatcher tells you they have all your information. Be prepared to tell the person on the other end of the phone line "who you are, where you are, and what the problem is". If you are in an apartment house with an alarm system, pull the alarm in order to alert the other tenants. You can dial 911 from a pay phone without putting any money in the phone. Public pay phones may not have a call back number.

## *REPORT ALL FIRES AND SMOKE*

Many times people are hesitant to call the Fire Department for small fires. There are a number of reasons for this. Some people feel themselves capable of handling the situation. Others are embarrassed that they had a fire, and don't want anyone to know. Some fear being charged for the service that the Fire Department provides. Consider the risks. Three reasons for making the call are:

- You are required by law to report fires.
- It is often necessary to have a fire report on hand from the Fire Department before an insurance company will pay compensation.
- Fires should be reported even when you think they have been put out so that they may be inspected by the Fire Department to insure that they have been completely extinguished.



# FAMILY FIRE SAFETY PLAN

A set of procedures for your home is a good thing to have when dealing with an emergency. As a family, discuss various emergencies and develop plans for how the family members are to deal with them. Survival rates increase in homes with emergency plans. A home evacuation plan should contain at least the following;

- Procedures for actions taken during an emergency
- An evacuation plan showing alternate escape routes • An assembly point.

## 1. Draw a floor plan of your home. Include the following:

- a. A primary and secondary exit route from each room. The primary route should be directly to the outside such as through the window.
- b. The location of any fire equipment
- c. Mark the area where everyone is to meet once they are outside of the house.
- d. Mark the location of utility shut-off switches and valves.

## 2. Physically check the exit routes to be sure that anyone, who will need to use them, can use them. This will clarify the need for things like escape ladders, ramps, security grill release mechanisms for protected doors and windows, and the availability of keys for double key locks.

## 3. Go over the plan with the entire family.

- a. Make sure that everyone understands that they are not to go back into the house or apartment once they are out. Go to the meeting area and wait.
- b. Discuss how to feel the door if it is closed and not to open it if it is hot.
- c. Talk about the danger of smoke and heat and the importance of staying low.
- d. Discuss what to do in the event that they become trapped.
- e. Be sure that everyone knows what the smoke detector sounds like.

The first thing to consider when formulating a plan is to have some method of being made aware of the danger. Smoke detectors are simple, automatic devices to provide that notification. You may also consider providing each bedroom with a whistle of some sort as a manual method of notifying the family to get out.

Sleeping with the doors closed provides barriers between those you love and night time fire in your home. The average household door will last approximately three to five minutes with a fully involved room. Closed doors have saved many lives by giving people the time to escape. Sometimes, people with small children or infants think that leaving, the door at night will enable them to hear in case their children cry or call out. In a fire the open door may allow toxic gases to enter the rooms and render both the parents and the children unconscious before any of them are aware of the problem. Inexpensive devices not only allows monitoring other rooms, but in some cases, communicating with them.

**At the sound of the alarm or if you suspect that there is a fire in your home, get out!** If you reach a closed door, feel it before opening. If it is hot, don't open it. Try to use a direct exit to the outside. If the door is cool to the touch, open it cautiously, keeping the door between you and the opening. Stay low and be prepared to close it quickly if heat or smoke is present. In the event that you must move through smoke, stay low, on hands and knees crawling quickly to the nearest exit. If you must break a window because it won't open, you can use a heavy object. Use it to punch out all of the glass starting from the top. Scrap the bottom edge of the window to remove fragments that may be sticking up and could injure you. Placing a blanket, pillow or article of clothing on the sill before you climb out provides additional protection.

Evacuation from a two story home or a second floor apartment can be a little more difficult. Consider is the purchase of an escape ladder. They are all designed to attach quickly to a windowsill.



(Available for three story buildings) It is important that every member of the family practice with the ladder.

In a two-story building, You must go out the window without a ladder, lower yourself out of the window feet first, facing the building. Hang down from the windowsill at arm's length, let go and drop to the ground. In this position in your average residence, an adult's feet are within six or seven feet of the ground.

# FAMILY FIRE SAFETY PLAN

## ADDRESSES

In the City of Los Angeles, buildings are required to have an address posted that is large enough to be seen from the street. The reason for this becomes very evident on those occasions when you have called 911 because you need help and your help is delayed because of difficulty in locating you because there is no address on the house is hidden or too small to read. You want them to find you, and find you quickly. It is always a good idea to send someone outside to meet the Fire Department to guide them to the emergency. This is especially true if you live in a large apartment complex with only one address for many units or even buildings.



## SECURITY BARS

Where security devices are used on windows and doors, it is important to remember that whatever keeps others from entering your home, can keep you and those you love from getting out. Make sure that everyone in the family knows how to use any release devices in the event of an emergency. Bars on windows should have quick release devices if they are installed on windows in a room where someone sleeps. Make sure that everyone in the home knows how to use any release devices in the event of an emergency. Test these devices at least twice a year to make sure they are working properly. Doors that require a key to open them from either side when they are locked should have the keys left in them on the interior side at night. Someone getting to that door without a key, or dropping a key in the smoke may never get out.



Regardless of how you got out of the building, go to the predetermined meeting place. Remember, if there is a fire in your home, get out and stay out. Practice your plan and take it seriously.

## APARTMENTS

If there is a fire in your apartment, get everyone out first and confine the fire by closing the doors. Turn in the alarm to both the building and the Fire Department. The same steps that were taken in a house should be followed in an apartment fire. It is important to slow the fire spread so other people will have time to evacuate the building should that become necessary. In this case, notification includes notifying the other tenants as well as the Fire Department. This may be done by activating the fire alarm system if the building has one, or by knocking on doors if that is the only way to let them know.

If you hear an alarm or smell smoke, but do not know where the fire is, evacuate but be cautious. Go out the door after feeling to see if it is hot. If it is hot, don't open it. Try another way, or if there is no other way, follow the advice given under what to do if you are trapped. Also remember that if you don't know where the fire is, it could be below you. Check every closed door that you have to open, including fire doors in the hallway and stairway doors. There could be fire on the other side. **Never use an elevator!**

Become familiar with your building. Learn where all the stairways are located and in the case of buildings three or more stories in height, find out which stairways give you the most options. For instance, some stairways have two doors at the bottom, one that goes into the building and one that goes directly to the outside. Some stairways go to the roof, some don't. In some buildings this can be a practical escape option. In multistory buildings in the City of Los Angeles you should find signs in the stairwell landings that will give you this information. Also you should know how to operate the fire alarms if the building is equipped with them. Fire doors in the halls should never be blocked open for any reason. These doors are to provide a barrier between you and a fire. If they are open, you lose that protection. This is also true of doors leading to the stairways. Open fire doors aid in the spread of the fire, fill hallways and stairways with smoke and heat and make escape difficult or impossible.

# FIRE SAFETY EQUIPMENT

## IF YOU ARE TRAPPED IN A ROOM OR APARTMENT

There may be a situation where there is no way to get out. It may be necessary to sit tight and wait for the Fire Department to put the fire out. Close as many doors between you and the fire as possible. Stuff the cracks of the door, and any vents that are allowing smoke into the room. If available, add additional material such as a mattress or a table over the door and prop them in place with other pieces of furniture. Make your location known. If there is a phone available and it works, call for help. If there is no phone, or it doesn't work, yell, hang a sheet out a window to get someone's attention. If you need to open a window do so, but avoid breaking the window if possible. The need may arise to close the window if smoke from outside is coming in.



## SMOKE DETECTORS

Tests have shown that smoke detectors of either the ionization or photoelectric type should provide adequate warning to the occupants for most residential fires. Ionization detectors respond slightly faster to open, flaming fires than the photoelectric type, but the photoelectric detectors respond faster to smoldering fires with little or no visible flame.

Detectors should be located on the ceiling at least four inches from the wall, or on the wall four to twelve inches from the ceiling to the top of the detector. In the City of Los Angeles, detectors are required in each sleeping room and the areas giving access to them.

Smoke detectors in your home can be of the battery-operated type or wired into your house electrical system, otherwise known as "hard wired". There are also dual function detectors that are hard wired but have a back-up battery in case of power failure. Choosing between photoelectric or ionization type is up to you as both types meet the accepted safety standards.

If you have battery operated smoke detectors you must maintain them, and make sure that the batteries are replaced

regularly. Do not remove the batteries because of nuisance alarms such as steam from showers etc. These problems should be dealt with in another manner such as moving the detector or simply closing doors. Studies have shown that in residential fires causing death, 60% of those residences did not have smoke detectors, had disconnected the smoke detectors, or had dead or missing batteries. Consider changing the batteries every six months. This would also be a good time to vacuum the detector and remove as much

dust as possible. This will help to insure that it will work properly when you need it. If you have hardwired detectors, consider purchasing a couple of battery type and mounting them in strategic places as a back-up system.

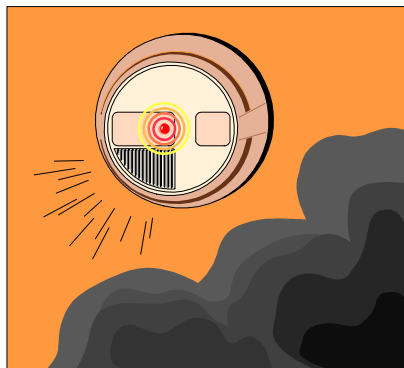

Some special considerations for the elderly or the handicapped may need to be addressed in your home. In general, households with elderly or handicapped occupants need a higher level of protection

in order to provide additional escape time. As an example, a supervised alarm system where the alarm is monitored by an alarm company that would call the Fire Department, or in the case of someone with a hearing loss, detectors that activate lights, bed shakers or fans.



# FIRE - SPECIFIC HAZARDS

Fire alarm systems that are monitored by an outside agency can serve a useful function and add a feeling of security to a family's home. However, don't let that become a false sense of security. Make sure that in the event of any smoke, fire or alarm that you also place a call to the Fire Department. After all, it is your home and your family. Never assume that the notification will be made for you by the alarm company.

## SPRINKLERS

In some areas, residential sprinkler systems are required in all new construction. If your house has sprinklers, generally the price of your fire insurance will go down. Be sure to tell your insurance company if you have had such an installation. The major positive aspect of sprinklers in your home is the fact that they will usually prevent a fire from spreading from one room and limit the area of damage. Never hang anything from the sprinkler heads. It is tempting around the holidays but this could cause accidental activation of the system or prevent the system from working when you need it.

## FLAMMABLE OR COMBUSTIBLE LIQUIDS

When working with flammable or combustible liquids, be sure that the area where you are working is well ventilated. If the air is kept moving through the area vapors levels are reduced and are less likely to reach dangerous concentrations. Make sure there are no ignition sources such as electric motors or pilot lights.

Don't use gasoline for cleaning purposes or for lighting barbecues. Gasoline vaporizes much too fast at room temperature to be safe. It can easily cause a fire or an explosion. It is much safer to use a commercial product

designed for cleaning. Don't apply barbecue starter fluid to hot briquettes, or any fire once it has been lit.

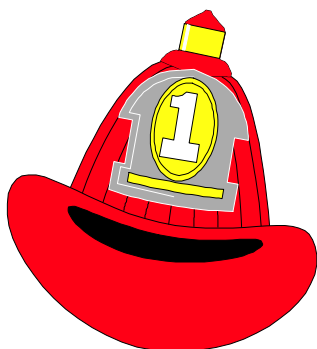

## SPONTANEOUS HEATING

Some materials, under certain conditions, can produce heat by themselves, and will burst into flame. This is commonly called spontaneous combustion. This is the accumulation of heat around a material due to oxidation at a rate sufficiently high to ignite it. Oxidation, which causes the problem, takes place around us all the time.

It's the process that causes steel to rust or turn paper yellow over a long period of time. Heat is given off in the process of oxidation, but generally at such a low rate that the air currents are able to dissipate it before it raises the temperature of the material that is oxidizing. When heat produced is greater than can be carried away, the material can heat to the point that it reaches its own ignition temperature.

Spontaneous heating can be prevented by keeping air away from the material as in a closed container, or by spreading the material out sufficiently that the heat produced by oxidation is carried away by the air. An example of sealing the material would be oily rags kept in a closed metal container. An example of allowing the air to dissipate the heat is spreading cut vegetation around instead of piling it in one place.

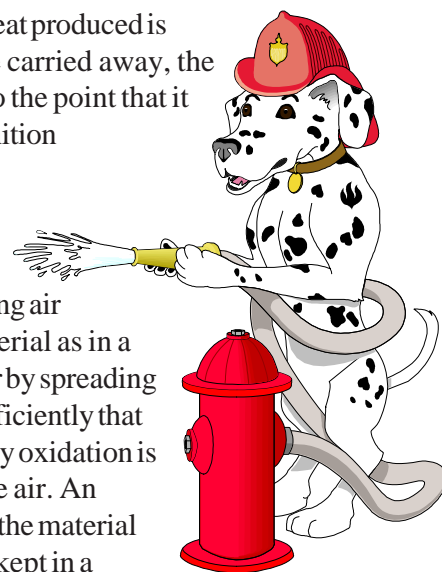

**Smoke** The best way to deal with smoke is to avoid it. A smoke filled hallway can be as dangerous as one filled with flame. **Most fire fatalities involve smoke.** If you must go through a smoky area, stay low and crawl on your hands and knees. Keep your head down. Some poisonous gases, being heavier than air, accumulate at floor level. The best air is at the height your face will be when you are on your hands and knees. The best choice may be to avoid the smoke and find another way out. If there isn't another way, then you must use the procedures discussed earlier in this booklet for what to do if you are trapped.



# SPECIFIC HAZARDS - CON'T

## CLOTHING FIRES

When a person's clothing is on fire, death or serious injury is only seconds away. Because tissue damage begins immediately, upon contact with flames it is essential to have a response planned which can be used in as wide a range of situations as possible, and still be effective.

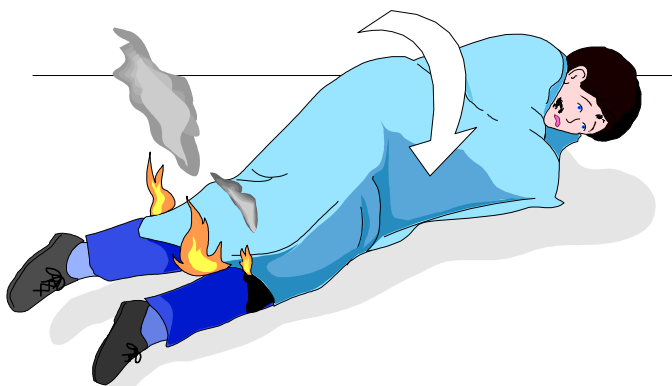

The **"Stop, Drop and Roll"** procedure that is taught in the schools is a good response to most situations. The intent here is not to discourage the use of additional tools and methods to extinguish a person's clothing, but to give you a place to start.

The purpose of the **"Stop"** is to keep you from running. Running provides more air moving through the clothing and can increase the amount and speed the fire progresses.

The purpose of the **"Drop"** is to get you into a horizontal position. Simply being in a vertical position will cause the fire to rapidly move up your body toward your face. In tests conducted by the National Fire Protection Agency on a woman's cotton dress, it was shown that a fire might travel from the hem to the collar in as little as ten seconds. By getting down in the horizontal position, you've changed the direction of the fire. You have stopped the fire's progress. It is no longer moving up your body toward your face. The most vulnerable portion of your body to heat is your respiratory tract. A single inhalation of flame into the delicate tissue of the lungs can be fatal.

The **"Rolling"** may smother the fire between your body and the floor surface, but even when this is not completely successful, it often reduces the amount of flame and therefore also slows the fire. If the fire does

not go out, grab whatever is handy to help cover and extinguish the fire, or try to remove the burning clothing.

## UPHOLSTERY FIRES

An upholstery fire poses two main dangers. The materials used to make furniture and mattresses allow fire to penetrate deeply and smolder for a long time. The problems most common to this type of fire are toxic gases associated with slowly burning materials, and difficulty in extinguishing.

Smoke inhalation is the cause of most mattress and upholstery fatalities. One of the gases that effects people early in the fire is carbon monoxide. Since hemoglobin and carbon monoxide are attracted about 200 times more readily than oxygen. The organ most susceptible to a shortage of oxygen is the brain. You may very quickly become disoriented and soon unconscious. One percent of carbon monoxide in your system is considered to be fatal.

Rekindle is another problem with fires in upholstery. Very often people will try to attempt to extinguish a small fire and succeed in eliminating the open flame. This may not be the end of the fire. There may still

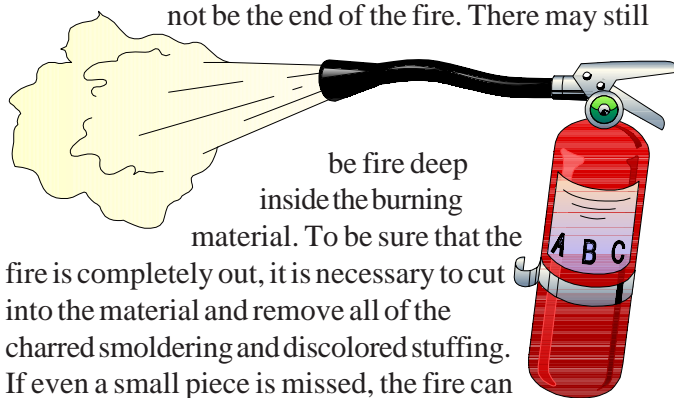

be fire deep inside the burning material. To be sure that the fire is completely out, it is necessary to cut into the material and remove all of the charred smoldering and discolored stuffing. If even a small piece is missed, the fire can grow again. This is an extremely dangerous situation, particularly at night, because the smell of the first fire hides the smell of the second one. The proper thing to do is to call the Fire Department to check it out. In any case, the burnt upholstery should never be left inside.

Home fire safety is often a matter of common sense, and a little forethought. Preparation and planning is the key to home fire safety.

**This page intentionally left blank.**

It is available for corporate support advertising.

Contact LAFD for terms and approvals.



**In Los Angeles for  
FIRE, POLICE & MEDICAL EMERGENCIES  
Call  
911**

Alternate Emergency Numbers -- The "911" emergency system for the Los Angeles area is overwhelmed with calls that are not actually emergencies. Calls for assistance with; a cat stuck in a tree, bugs, dogs in labor, requests for rides to the doctor, etc. are among the type of calls received by the 911 operators. These incidents may be an urgent matter for the caller but are not "life threatening" emergencies. With so many calls (both emergency and non-emergency) flooding the 911 system it is not uncommon to get a busy signal.

**Alternate Emergency Telephone Number**

**If for any reason you cannot get through to the emergency 911 operator,  
call the alternate emergency number.**

**For Fire or Paramedics  
1-800-688-8000**

FOR ADDITIONAL  
INFORMATION CONTACT

**DISASTER PREPAREDNESS UNIT (818) 756-9674  
FIRE & SAFETY EDUCATION UNIT (818) 756-9671**

**WWW.LAFD.ORG**